

Henry Valentine ([valenth1@my.erau.edu](mailto:valenth1@my.erau.edu))

Aroh Barjatya, Robert Clayton, Nathan Graves, Josh Milford, Peter Ribbens, Rachel Conway

## Abstract

The Space and Atmospheric Instrumentation Laboratory at Embry-Riddle Aeronautical University has developed a highly sensitive Positive Ion Probe (PIP) instrument capable of conducting high-cadence (5KHz) distributed relative-ion density measurements from a sounding rocket platform. The PIP features a unique auto-ranging electrometer design which allows for extremely sensitive wide-range in-situ plasma measurements. The instrument was debuted on a mid-latitude sounding rocket mission, called SpEED Demon, which launched from NASA's Wallops Flight Facility in August 2022. SpEED Demon incorporated a comprehensive suite of instruments for aerodynamics and neutral dynamics measurements. Included in this collection of instruments were multiple PIP sensors. The PIP suite of instruments consisted of a single boom-deployed spherical sensor on the main rocket payload and a cylindrical sensor on each of four ejectable subpayloads which allowed for simultaneous spatially-distributed measurements of ion density. The interpretation of these measurements may provide an understanding of patchy, small-scale plasma density gradients, horizontally and vertically, through a myriad of ionospheric phenomena. This work presents the PIP instrument design, calibration, and preliminary flight results from the SpEED Demon launch.

## SpEED Demon Mission Overview

**Sporadic-E ElectroDynamics Demonstration** – or SpEED Demon – was a sounding rocket mission launched from NASA's Wallops Flight Facility on August 23<sup>rd</sup>, 9:16 PM local time. The rocket's instrumentation suite was developed by Embry-Riddle Aeronautical University's Space and Atmospheric Instrumentation Laboratory (SAIL) with payload support and launch vehicle provided by NASA. The mission served as a technology demonstration flight for the upcoming SEED rocket campaign, scheduled to launch from Kwajalein in 2024. SpEED Demon was able to fly through and collected data from a mid-latitude Sporadic E Layer.

## Launch Details

- August 23<sup>rd</sup>, 9:16 PM Local time. NASA Wallops Flight Facility, Virginia. 160 km apogee.

## Instrumentation

- Langmuir probe suite, magnetometers, accelerometers, ionization gauge, electric field measurement, 4 ejectable subpayloads (called ROB's).

## Positive Ion Probe

The Positive Ion Probe (PIP) is a Langmuir probe instrument which maintains a fixed-bias in the ion saturation region (Figure 2). That is, the probe is biased negative with respect to the plasma so that electrons are repelled, and positive charge is collected on the instrument's conductive surface. Analysis of the collected current allows for high-cadence *in-situ* measurements of relative change in ion density. The data are expressed in terms of absolute density only after measurements from other instruments have been considered. On the SpEED Demon rocket, there were 5 PIP instruments. One was installed on the main payload, mounted on a deployable boom and 4 were integrated into the ejectable subpayloads. Figure 1 shows each instrument prior to integration. In addition to the PIP, each subpayload also carried an accelerometer, magnetometer, and GPS receiver.

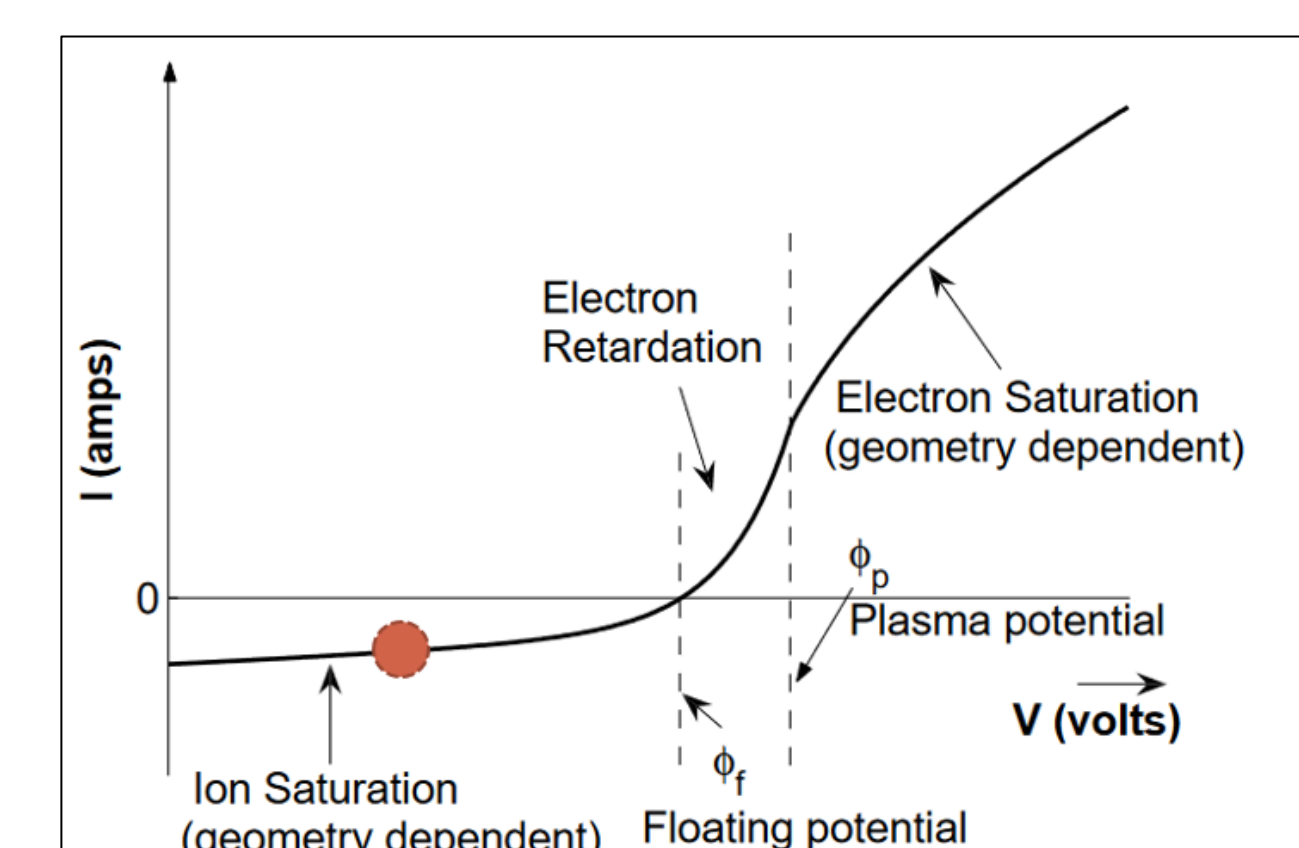
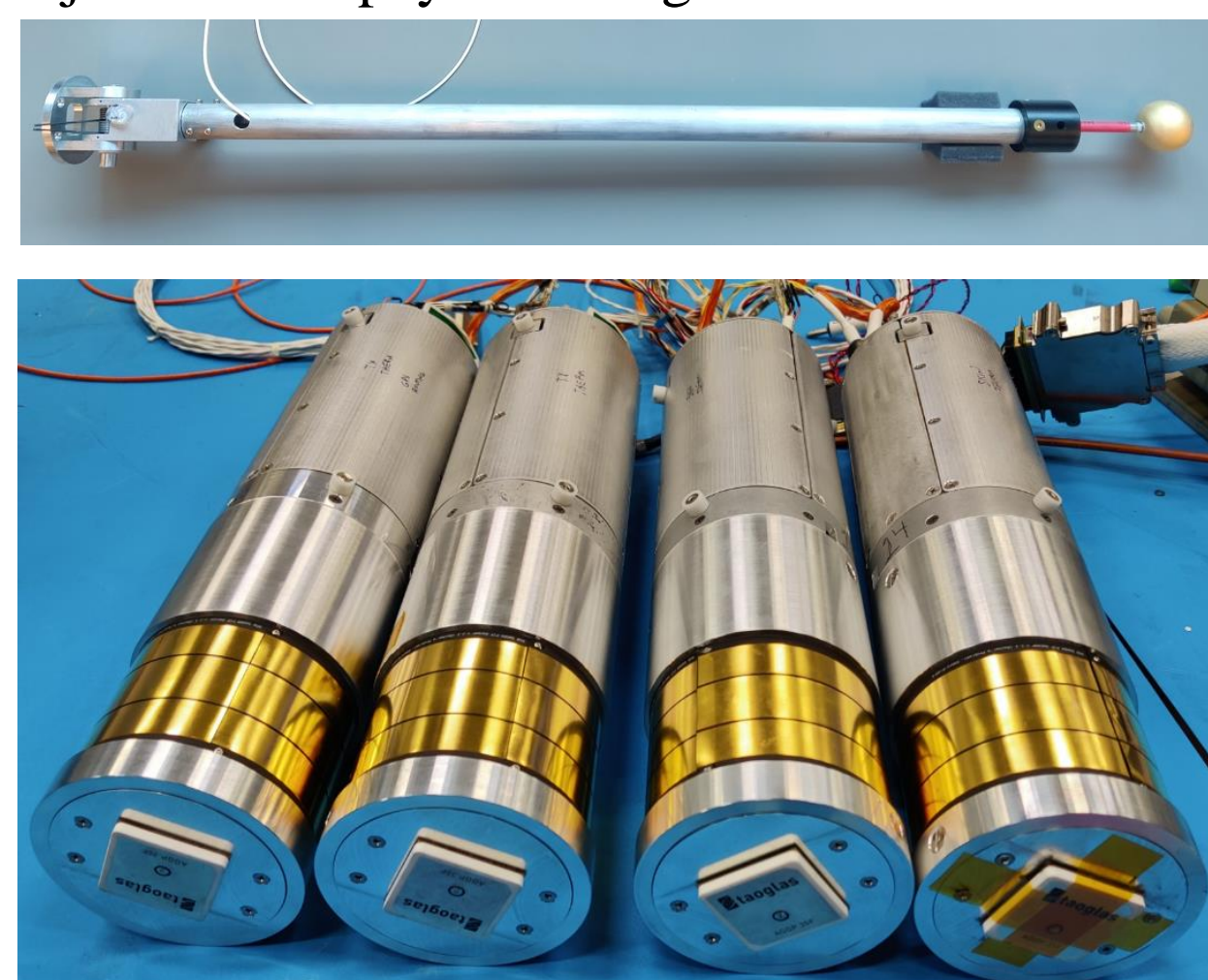

Figure 2: IV curve for a general Langmuir probe. PIP instruments are biased negative w.r.t plasma (orange dot) and collect ion current [1].

## Instrument Design and Specifications

Table 1 shows a summary of instrument specifications for the main payload and sub-payload PIP instruments. Each PIP is comprised of 4 distinct systems (as shown in Figure 3): A metallic probe immersed in plasma, a 2-stage auto-ranging wide-band analog electrometer to collect plasma current, a 24-bit analog to digital converter, and digital circuitry to process data and interface with the rocket telemetry system. For each probe, an electrical guard whose bias voltage is identical to that of the sensor is used to prevent fringe effects and further liken the behavior of the instrument to its theoretical model. Figure 3 also shows the PCB's for the subpayload PIPs (left) and the main payload PIP (right). The ROB PCB's were contained within the subpayload body, shown in Figure 1, and the main payload PIP PCB was installed in an E-box on the rocket.

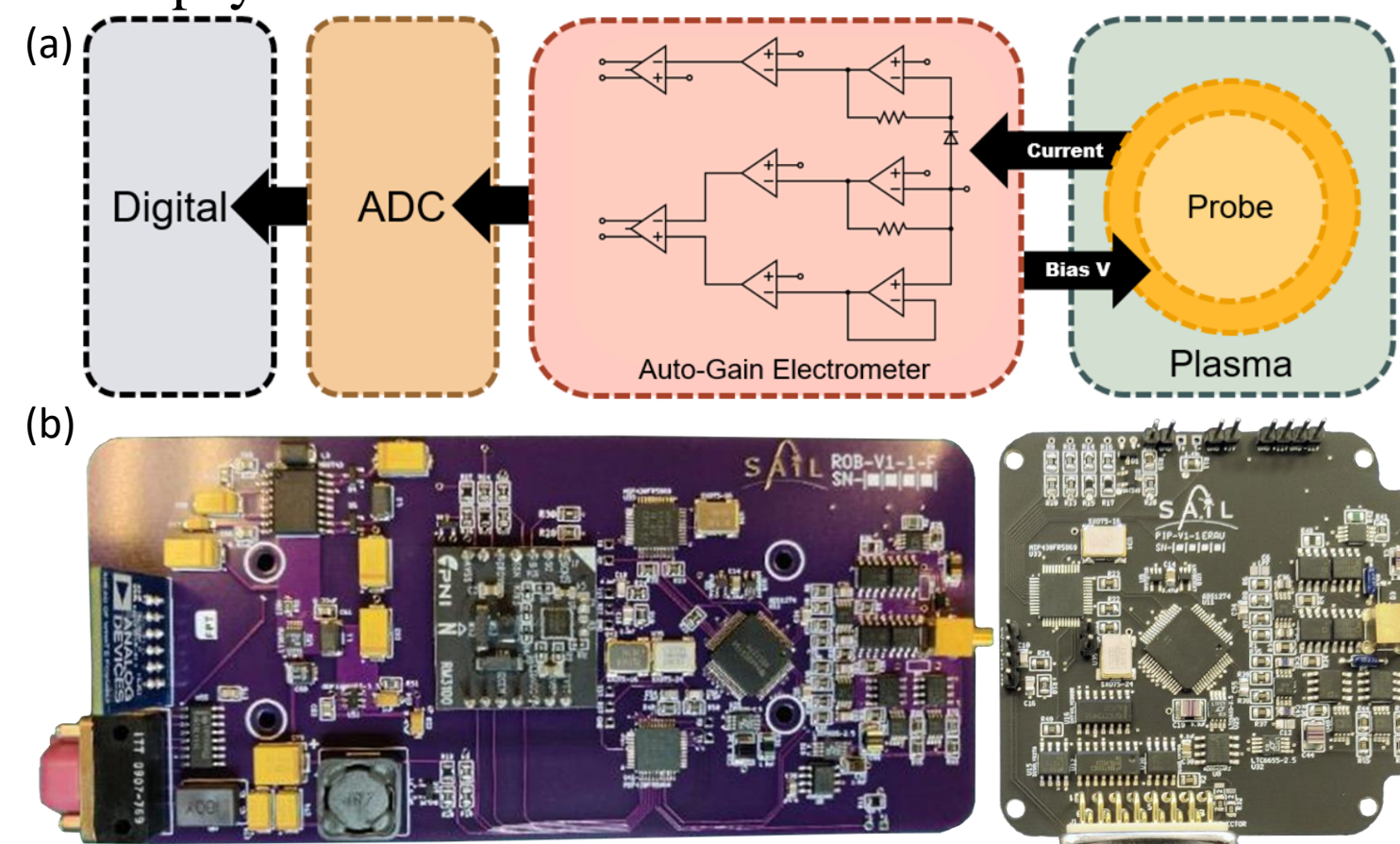

Figure 3: (a) Block diagram of PIP circuit. (b) PCB's for subpayload (left) and main payload PIP (right)

Instrument Specs		
Parameter	Main Payload	Sub-Payload
Bias Voltage	-6 V	-6 V
Sensor Geometry	Sphere	Cylinder
Sensor Material	Gold-Plated	Gold-Plated
Sensor Area	45.6 cm <sup>2</sup>	52.8 cm <sup>2</sup>
Current Resolution	0.05 nA	0.05 nA
Density Resolution	< 100 cc <sup>-1</sup>	< 100 cc <sup>-1</sup>
Calibration Accuracy	0.1 nA	0.1 nA
Dynamic Range	3X10 <sup>5</sup>	6X10 <sup>5</sup>

Table 1: Instrument specifications for the main payload and sub-payload PIPs.

## PIP Calibration

The main payload and subpayload PIP instruments were calibrated in-house at Embry-Riddle's Space and Atmospheric Instrumentation Laboratory. The procedure was intended to accomplish the following goals:

- Calibrate input current as a function of ADC counts and board temperature
- Calibrate sensor bias voltage as a function of temperature and current load

The calibration setup block-diagram is displayed in Figure 4 while Figure 5 shows an image of the actual calibration facilities in the lab. A Test Equity 115A humidity-controlled temperature chamber was used to consistently and accurately vary the environment temperature. Calibration was performed over a temperature range of 25°C to 55°C in 10°C steps following a power-off 65°C bake (see Figure 6). A Keithley 2450 sourcemeter was used to provide accurate current inputs over each device's full acceptable range and was used to measure each instrument's bias voltage under load. A least-squares fit was applied to the resulting calibration data in order to obtain calibration equations in terms of the variables listed above. The fit residuals for ROB 1 are shown in Figure 7.

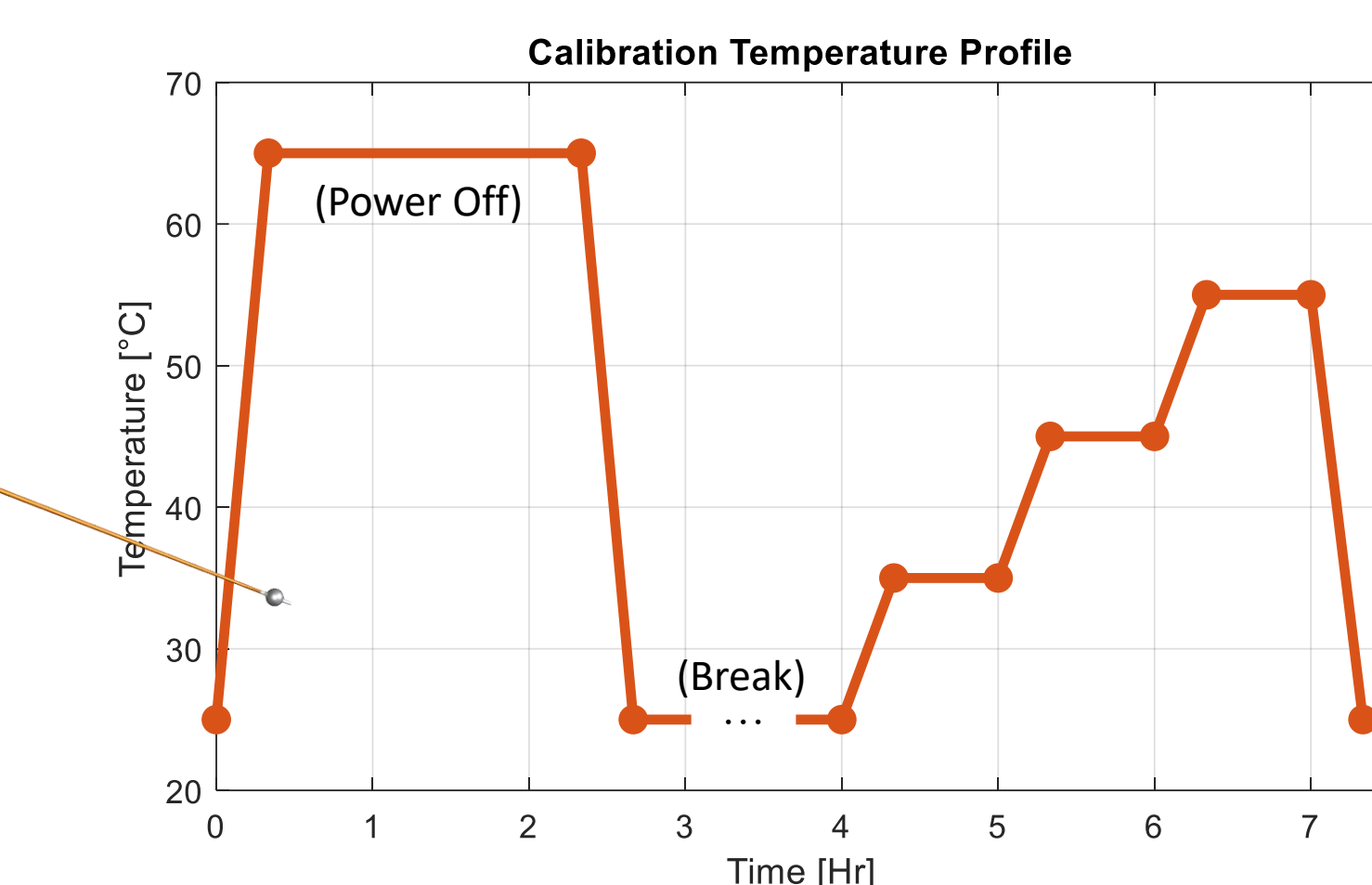

Figure 6: Calibration thermal profile for PIP instruments. After the power-off bake, only one PIP was calibrated at a time. Others were removed at 25°C.

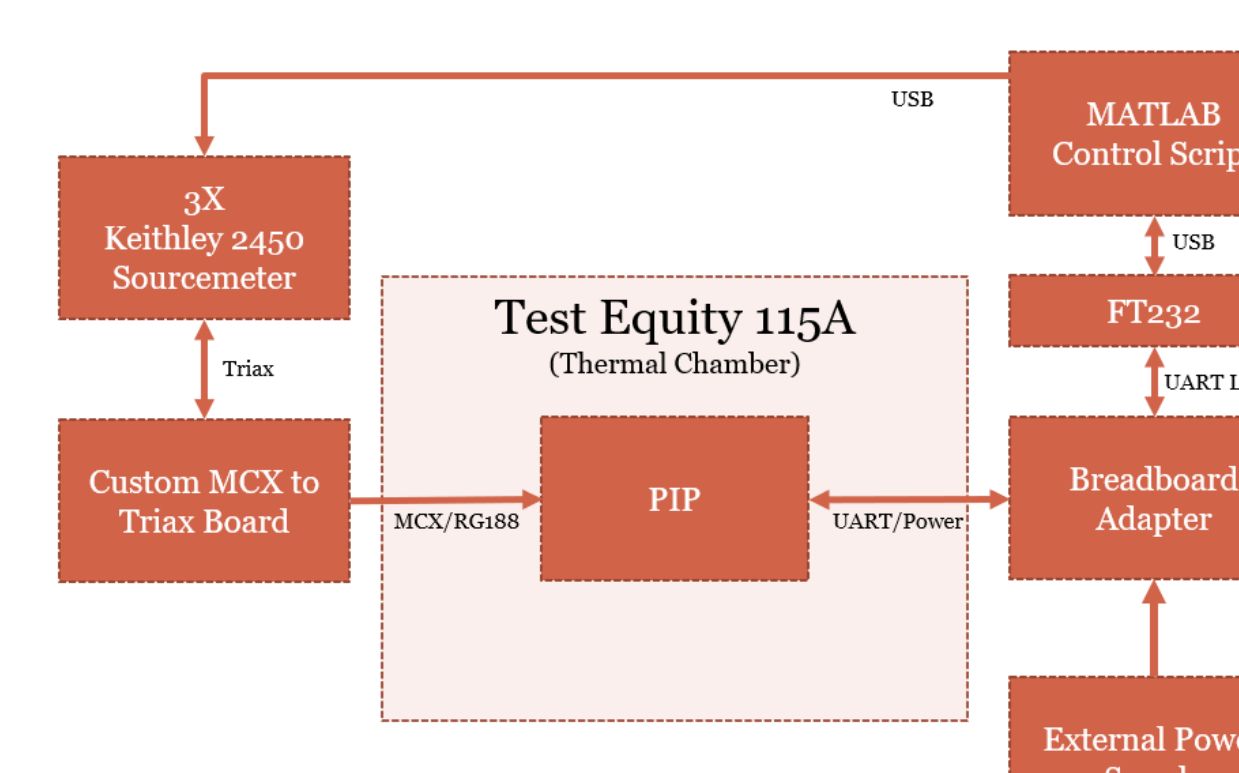

Figure 4: Block diagram of the PIP calibration setup.



Figure 5: Image of the calibration setup in SAIL. Test Equity 115A shown on right. Left: 3 Keithley 2450 sourcemeters for simultaneous calibration.

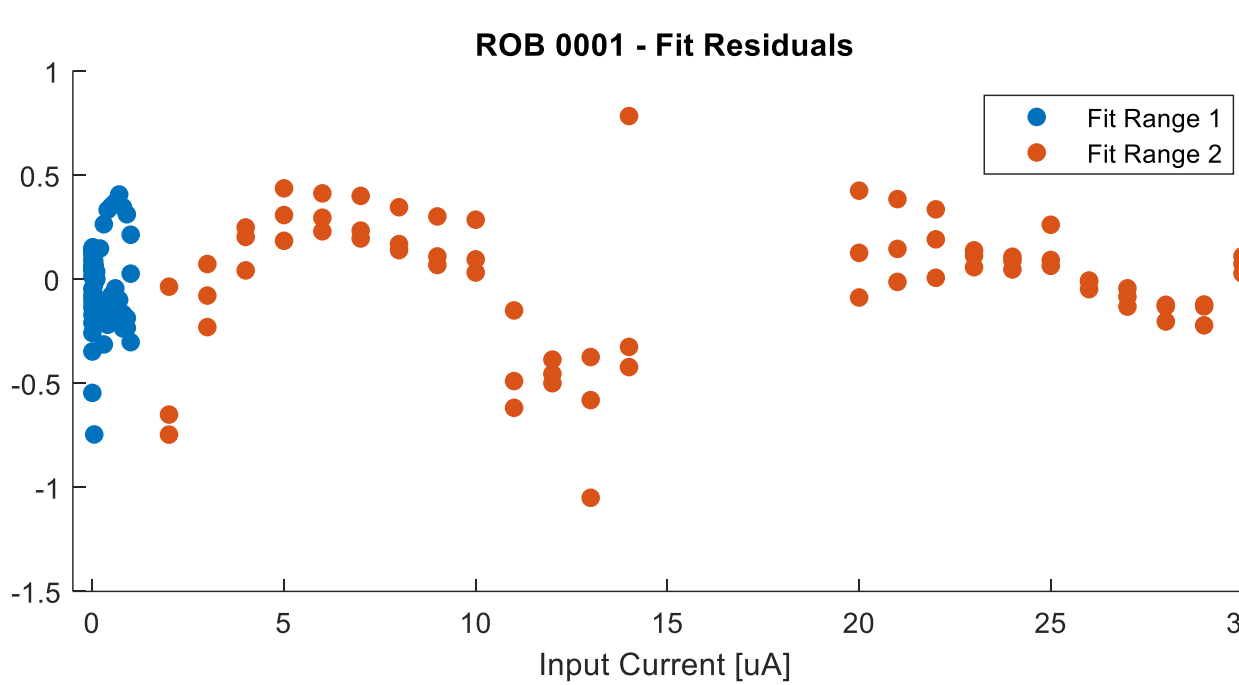

Figure 7: Fit residuals for ROB 1 calibration data. Fit was broken into two ranges due to non-linearity at low currents.

## Subpayload and Main Payload PIP Flight Data

Figure 8 shows the calibrated current measurements for the subpayload and main payload PIP instruments. The data from each probe are superimposed and plotted as a function of altitude. The large feature present in each plot indicates that the SpEED Demon rocket and subpayloads flew through a sporadic E layer between 100 km and 105 km on both the upleg and downleg of the flight. The signal was lower than expected, peaking within ~1% of each instrument's acceptable input range. Nevertheless, the sensitivity of each proved sufficient to clearly resolve the E layer and several instances of small high-frequency fluctuations in ion density.

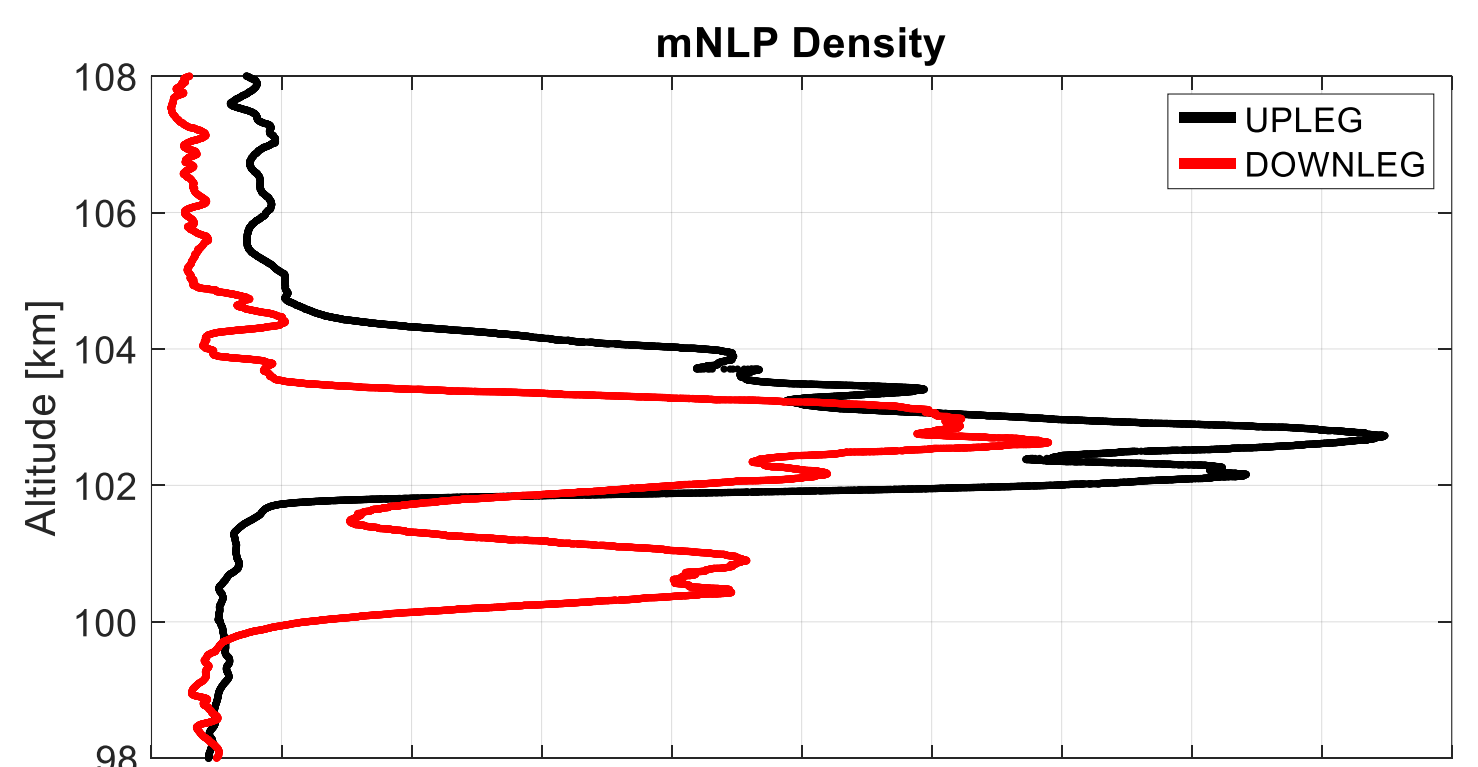

Figure 8: Calibrated current measurements for the main payload PIP and each of the 4 ROB subpayloads.

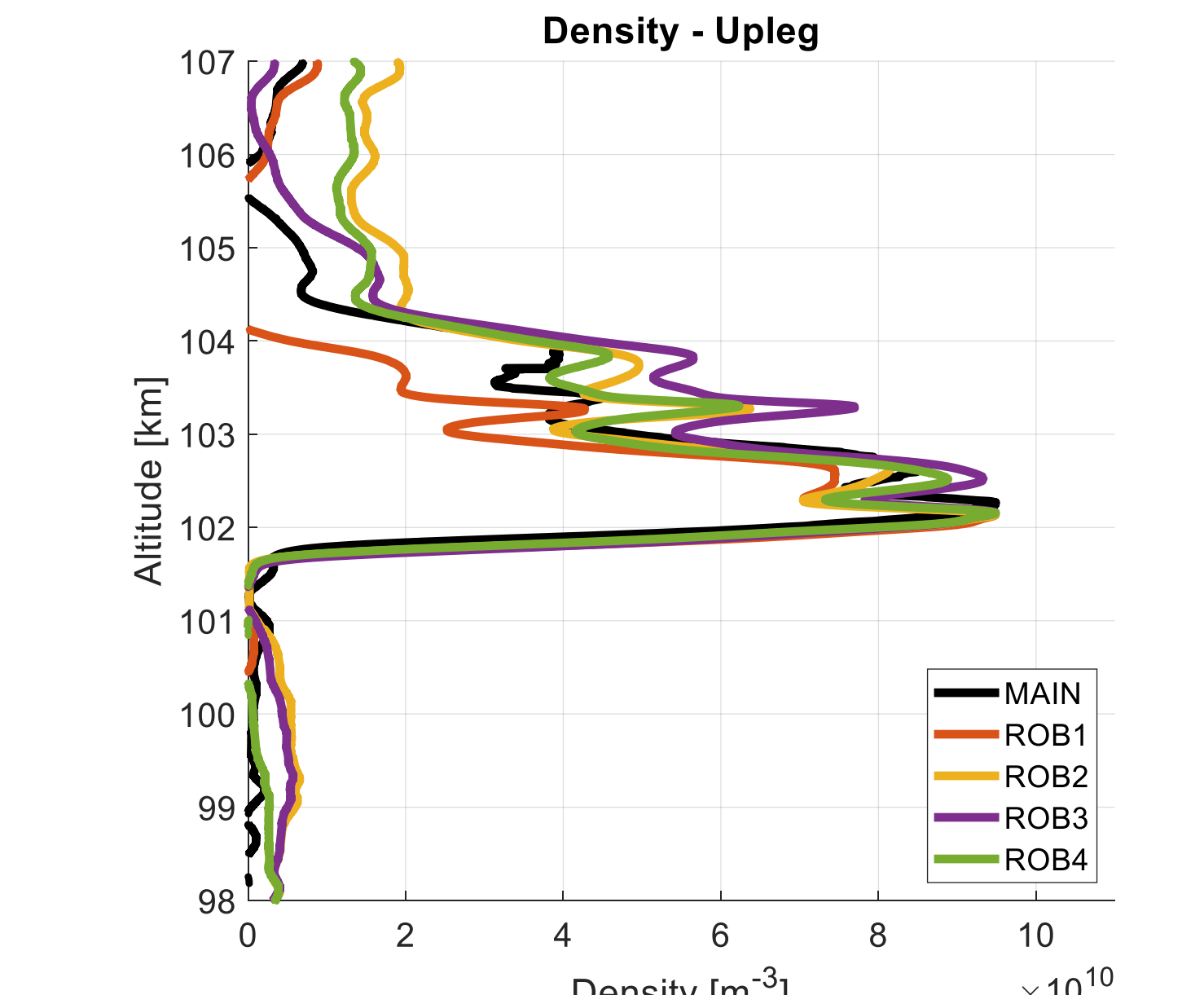

Figure 9: Absolute electron density measurements acquired from the multi-Needle Langmuir Probe (mNLP).

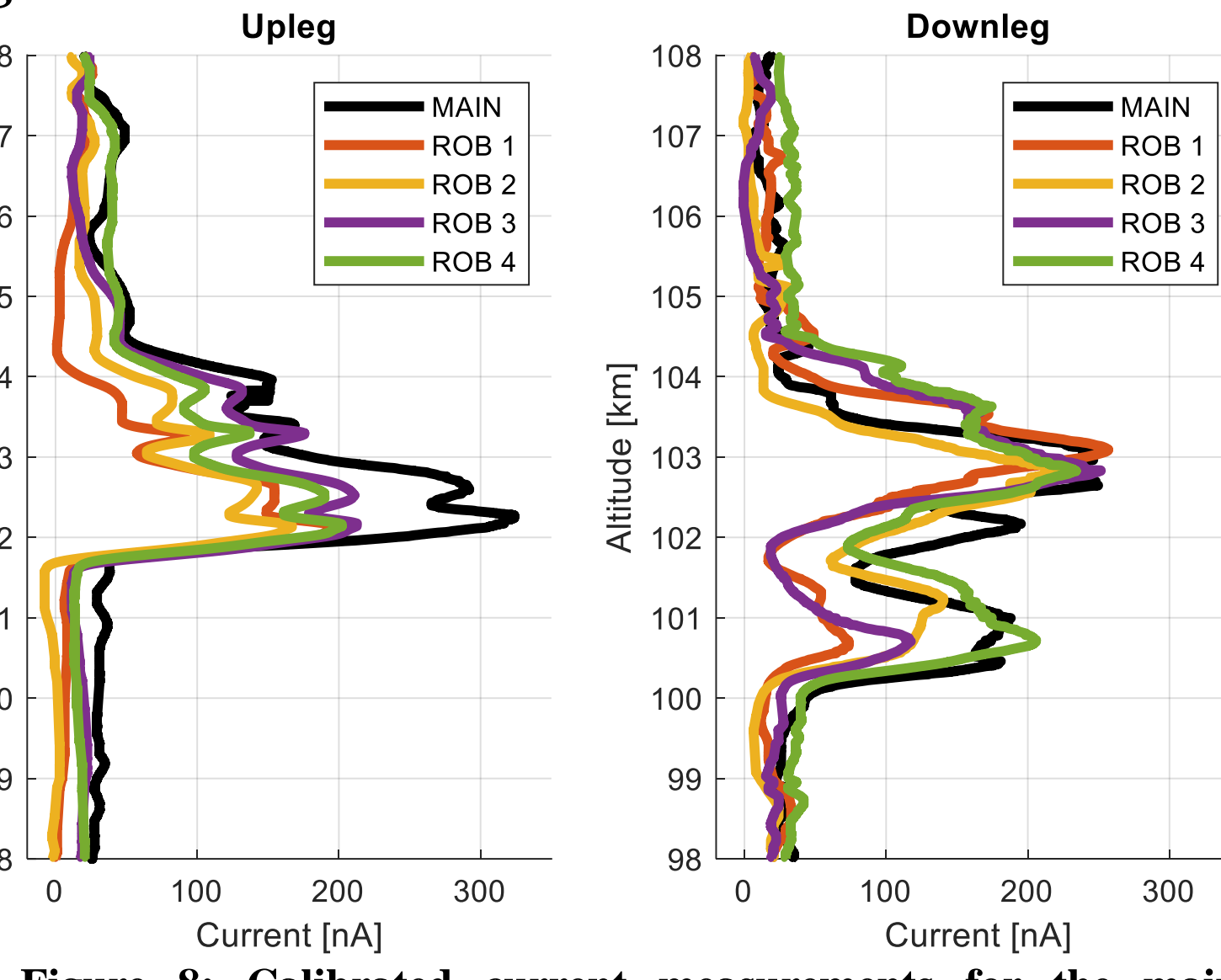

Figure 10: Superimposed main payload and subpayload PIP ion density profiles. Current data from each instrument were scaled to match the mNLP E-layer max density. Magnified region shows high freq. fluctuations.

## ROB Flight Path and Attitude

The ROB subpayloads were stowed 90° apart from each other within the rocket payload and were ejected in pairs (ROB 1 & 3, ROB 2 & 4). The second pair was ejected approximately 1s after the first. The deployment times and altitudes are as follows:

ROB1/ROB3 : 63.6 s, 75.0 km

ROB2/ROB4 : 64.7 s, 76.2 km

where times are expressed in seconds after launch. The subpayloads drifted away from the main payload as shown in Figure 11. The ejections were not 90° due to ACS issues. Figure 13 shows the angle between the long axis of ROB 1 and the ram direction over the duration of the flight. Each subpayload was coning at rate of 0.1-0.2 Hz, thereby periodically reducing the cross-sectional area of the PIP sensor. Work to correct density errors caused by subpayload attitude is ongoing.

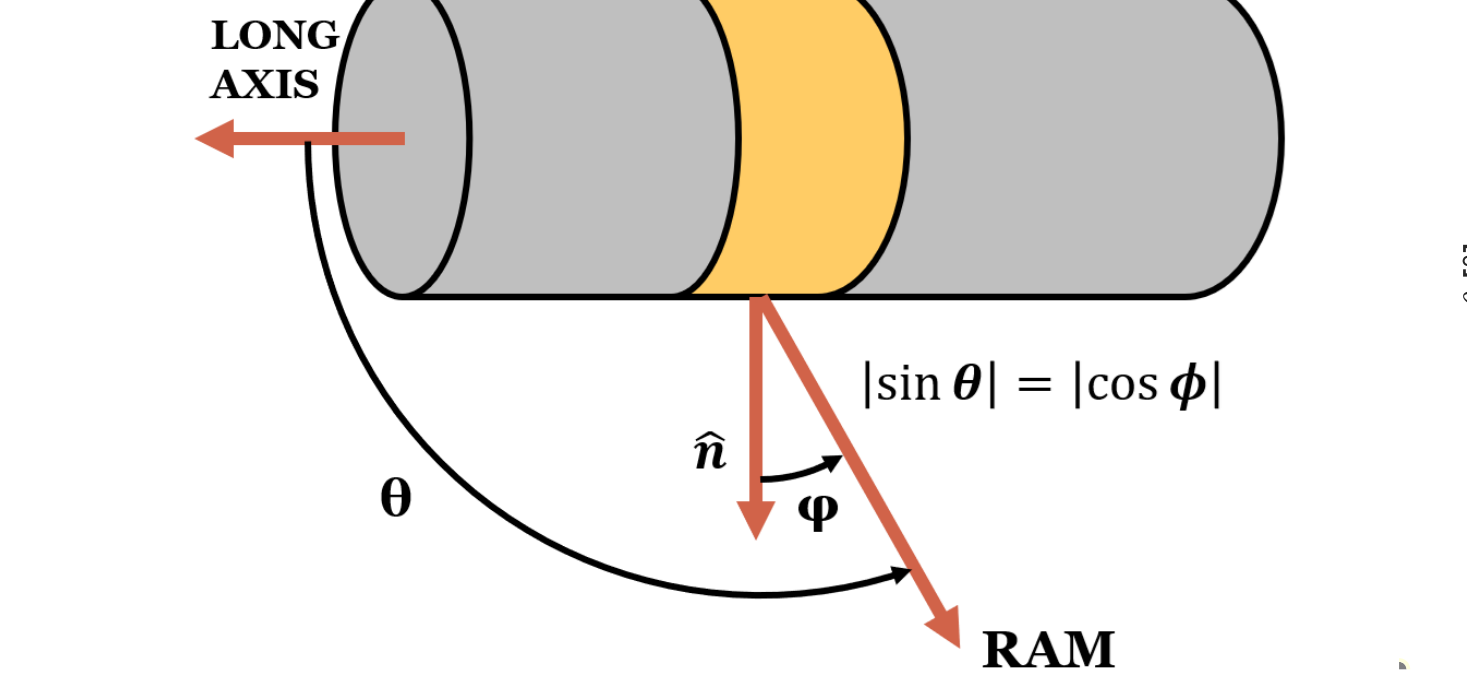

Figure 12: ROB subpayload long axis and sensor (shown in gold) angle to ram.

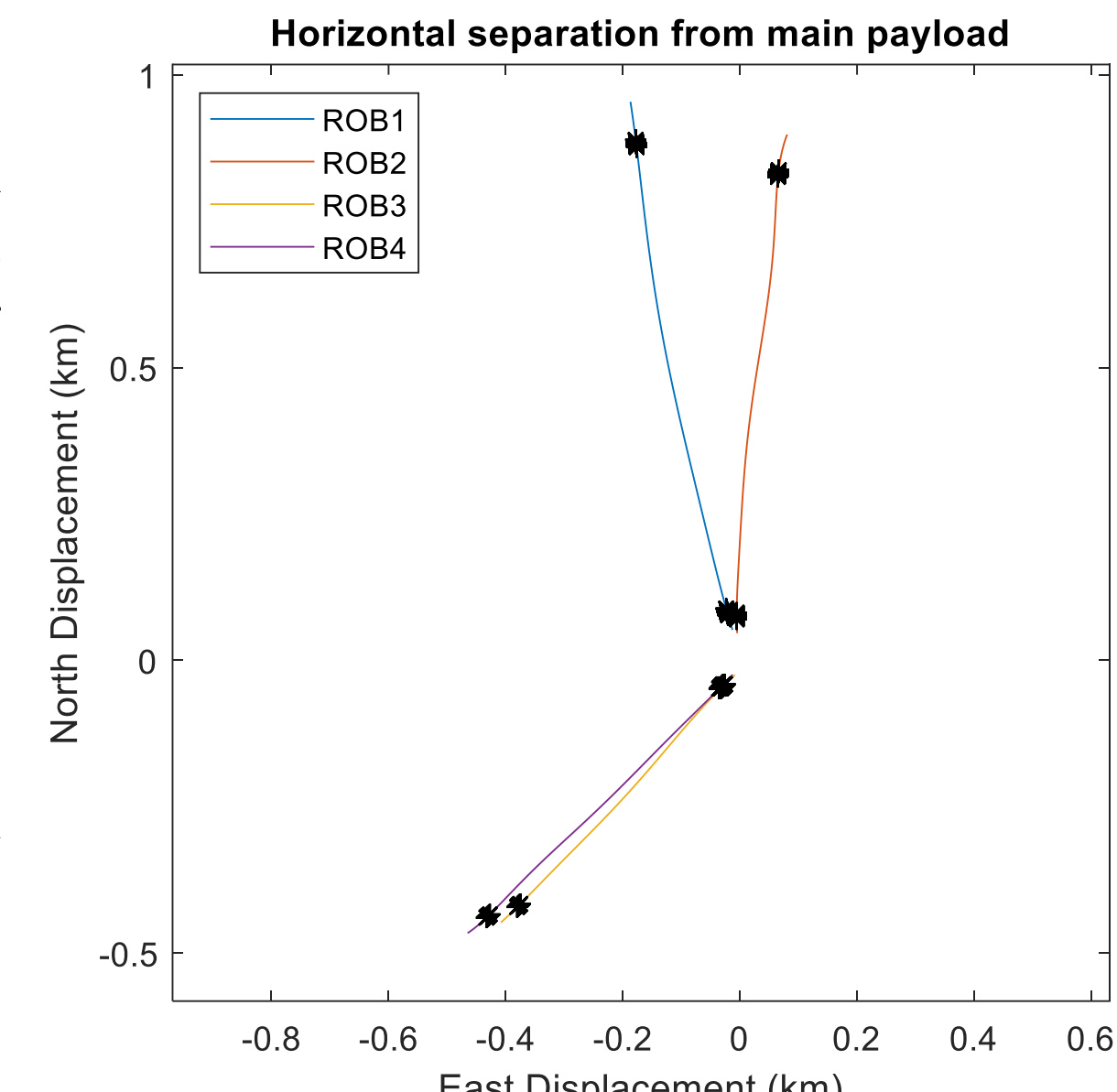

Figure 11: Horizontal displacement of the ROB subpayloads from main payload. Black marks indicate the Es layer intersections.

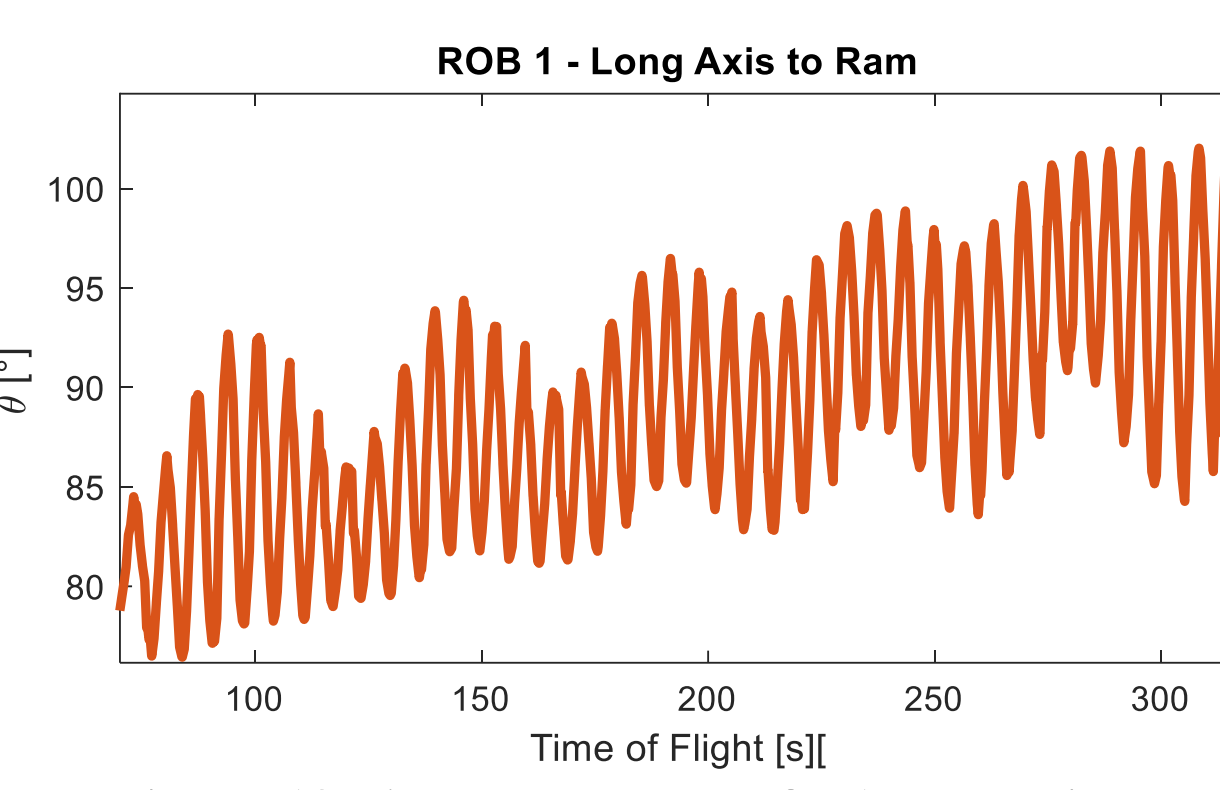

Figure 13: Angle between ROB1 long axis and ram direction over time of flight.

## High-Frequency Density Oscillations

Figure 14 shows spectrograms computed during the Es layer for all PIP instruments. Density data for each were binned into 0.1s segments and fit to a 3<sup>rd</sup> order polynomial. The fit was subtracted from the data and an FFT was performed in order to form each spectrogram. Bright yellow areas indicate regions where high-frequency oscillations were observed, such as the ones shown in the magnified section of Figure 10. It is not immediately clear what is causing these oscillations. Further investigation is merited and will be performed.

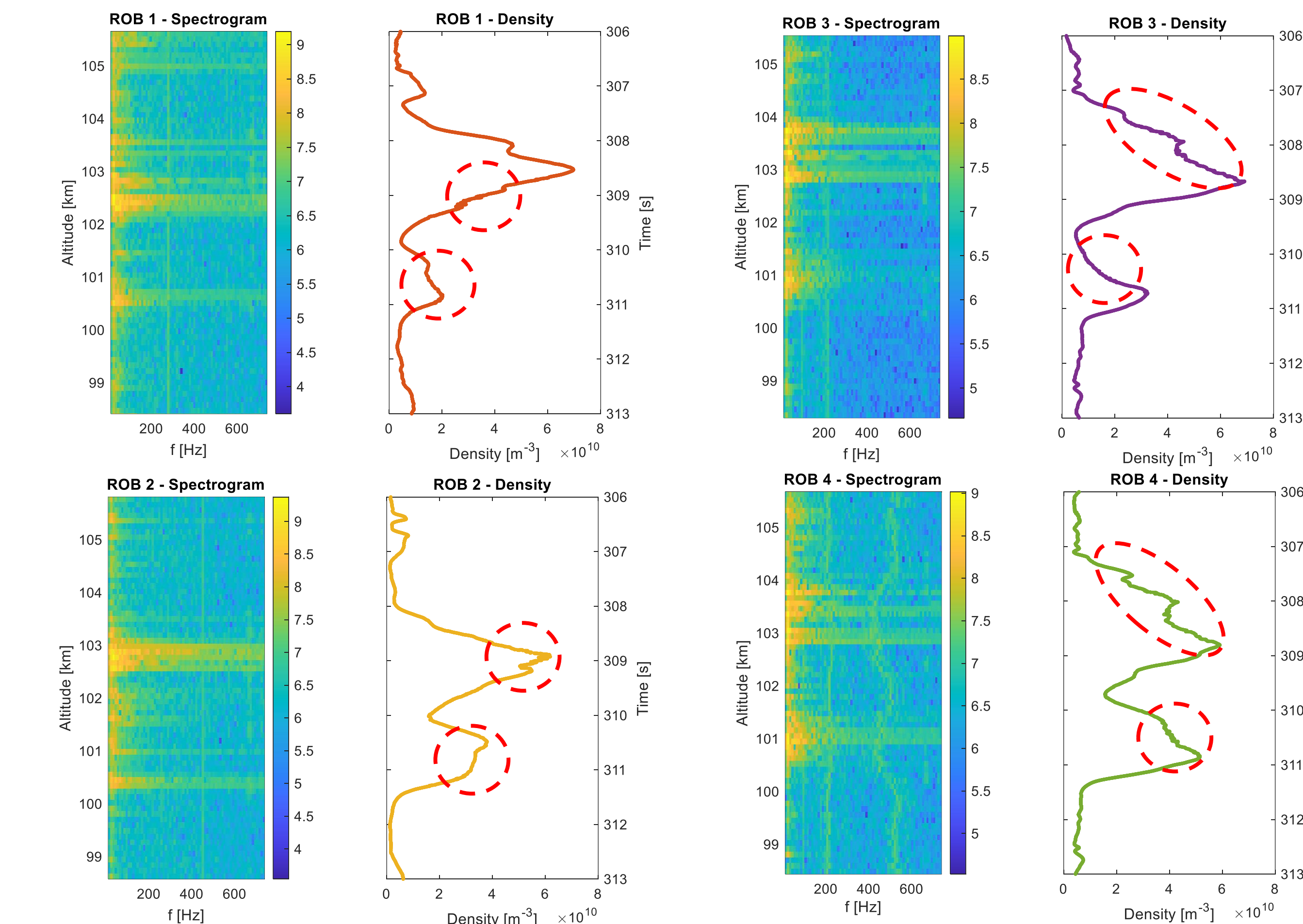

Figure 14: Spectrograms of Es layer for all SpEED Demon PIP instruments. Regions with high spectral density (bright yellow), correspond to high-frequency density oscillations circled in red.

## Takeaways and Future Work

- This work presents the design, calibration and initial results of the SpEED Demon PIPs.
- Initial analysis shows that ejectable subpayloads can be effective in performing simultaneous multi-point relative ion density measurements from a sounding rocket.
- Next Step: Finalize subpayload attitude solutions and use these to correct and account for the effects of coning on the ion density data.
- The source and effects of high-frequency oscillations in the PIP data will be further examined.
- We will compute horizontal and vertical plasma density gradients throughout the Es layer using corrected main payload and subpayload PIP density measurements and GPS data.

## References

Barjatya, A. (2007). Langmuir Probe Measurements in the Ionosphere. PhD Dissertation, All Graduate Theses and Dissertations. 274. <https://digitalcommons.usu.edu/etd/274>